

WV-S4576LA

12MP Sensor IR Outdoor 360 Fisheye Network Camera with AI engine

Edge AI 360-degree fisheye camera for video surveillance and business intelligence



- 12MP Outdoor 360-degree fisheye camera
- Up to 3 Edge AI analytic apps
- Built-in IR-LED(14m, 45ft)
- IP66, IK10 certified
- Built-in FIPS 140-2 Level 3 Certified SecureElement (EdgeLock® SE050F NXP® Semiconductors)
- NDAA Compliant



SPECIFICATIONS

Camera	
Image Sensor	Approx. 1/2 type 12MP CMOS image sensor
Minimum Illumination	Color : 0.3 lx BW : 0.04 lx (F1.9, Maximum shutter : Off (1/30 s), AGC : 11) BW : 0 lx (F1.9, Maximum shutter : Off (1/30 s), AGC : 11, when the IR LED is lit) Color : 0.02 lx BW : 0.003 lx (F1.9, Maximum shutter : max. 16/30s, AGC : 11)
Intelligent Auto	On / Off
Maximum Shutter	max. 16/30s to Max. 1/10000s
Wide Dynamic Range	On / Off, The level can be set in the range of 0 to 31.
Dynamic Range	Max.84 dB (Wide Dynamic Range : On, level : 31)
Image Settings	Gain (AGC), White balance
Image Compensation	Adaptive black stretch, Back light compensation (BLC), Fog compensation, High light compensation (HLC), Digital noise reduction
Color/BW (ICR)	Off / On (IR Light Off) / On (IR Light On) / Auto1 (IR Light Off) / Auto2 (IR Light On) / Auto3 (SCC)
IR LED Light	High* / Middle / Low / Off *Maximum irradiation distance : 14 m{Approx. 45 ft}(30IRE), 10 m {Approx. 33 ft} (Mounting height : Approx. 3 m, Peripheral intensity control : On)
Video Motion Detection (VMD)	On / Off, 4 areas available
Scene Change Detection (SCD)	On / Off, 1 areas available
Audio Detection	On / Off
AI Sound Classification	Gunshot, Yell, Vehicle horn, Glass break
AI Analytics	AI-VMD/AI People Counting for 360-degree fisheye camera, AI Privacy Guard for 360-degree fisheye camera, AI Scene Change Detection For details : https://i-pro.com/products_and_solutions/en/surveillance/products/analytics-software 3rd party applications are also available. https://i-pro.com/products_and_solutions/en/surveillance/solutions/edge-ai-platform/application-list
Privacy Zone	On / Off, Up to 8 zones available
Camera Title (OSD)	On / Off, Up to 20 characters (alphanumeric characters, marks)
Fixing angle adjustment	-5°, 0°, +5°
Lens	
Zoom Ratio	1x
Digital (Electronic) Zoom	Choose from 3 levels of x1, x2, x4
Focal Length	1.4 mm {1/16 inches}
Maximum Aperture Ratio	1:1.9
Focus Range	0.5 m {19-11/16 inches} - ∞
Angular Field of View	Horizontal : 183° Vertical : 183°

DORI	
Distance to the object in the center of the image	Detect (25 ppm / 8 ppf) : 29.9 m / 98.2 ft Observe (62.5 ppm / 19 ppf) : 12.0 m / 39.3 ft Recognize (125 ppm / 38 ppf) : 6.0 m / 19.6 ft Identify (250 ppm / 76 ppf) : 3.0 m / 9.8 ft
Coverage radius when mounted at a height of 3 m (10 ft)	Detect (25 ppm / 8 ppf) : 56.1 m / 184.2 ft Observe (62.5 ppm / 19 ppf) : 20.6 m / 67.6 ft Recognize (125 ppm / 38 ppf) : 8.4 m / 27.6 ft Identify (250 ppm / 76 ppf) : 0.3 m / 0.9 ft
System on Chip (SoC)	
System on Chip (SoC)	Ambarella CV22
Browser GUI	
Camera Control	Brightness, AUX On / Off
Audio	Mic (Line) Input : On / Off Volume adjustment : Low / Middle / High Audio Output : On / Off Volume adjustment : Low / Middle / High
GUI / Setup Menu Language	English, Italian, French, German, Spanish, Portuguese, Russian, Chinese, Japanese
Network	
Network IF	10Base-T / 100Base-TX, RJ45 connector
Resolution <Ceiling> <Wall>	<ul style="list-style-type: none"> •Fisheye mode (max. 30 fps/25 fps) 2992×2992 / 2192×2192 / 1280×1280 / 640×640 / 320×320 •Quad PTZ mode (max. 15 fps/12.5 fps), Single PTZ mode (max. 15 fps/12.5 fps) 2560×1920*3 / 2048×1536 / 1600×1200 / 1280×960 / 800×600 / VGA / QVGA
Resolution <Ceiling>	<ul style="list-style-type: none"> •Double Panorama mode (max. 15 fps/12.5 fps) 2560×1440 / 1920×1080 / 1280×720 / 640×360 / 320×180 •Fisheye + Double Panorama mode (max. 15 fps/12.5 fps) (Fisheye) 2992×2992 / 2192×2192 / 1280×1280 / 640×640 / 320×320 (Double Panorama) 1280×720 / 640×360 / 320×180 •Fisheye + Quad PTZ mode (max. 15 fps/12.5 fps) (Fisheye) 2992×2992 / 2192×2192 / 1280×1280 / 640×640 / 320×320 (Quad PTZ) 1280×960 / 800×600 / VGA / QVGA •Quad streams mode (Single PTZ (Quad streams)) 1280×960 / 800×600 / VGA / QVGA (max. 15 fps/12.5 fps) (Quad PTZ) 2560×1920 / 2048×1536 / 1600×1200 / 1280×960 / 800×600 / VGA / QVGA (max. 5 fps)
Resolution <Wall>	<ul style="list-style-type: none"> •Panorama mode (max. 15 fps/12.5 fps) 2560×1440 / 1920×1080 / 1280×720 / 640×360 / 320×180 •Fisheye + Panorama mode (max. 15 fps/12.5 fps) (Fisheye) 2992×2992 / 2192×2192 / 1280×1280 / 640×640 / 320×320 (Panorama) 1280×720 / 640×360 / 320×180
H.265/H.264	Transmission Mode : Constant bit rate / VBR / Frame rate / Best effort Transmission Type : Unicast port (AUTO) / Unicast port (MANUAL) / Multicast
JPEG	Image Quality :10 steps
Smart Coding	GOP (Group of pictures) control : On (Frame rate control) * / On (Advanced) * / On (Mid) / On (Low) / Off *On (Frame rate control) and On (Advanced) are only available with H.265. Auto VIQS : On / Off
Audio Compression	G.726 (ADPCM) : 16 kbps / 32 kbps ,G.711 : 64 kbps, AAC-LC : 64 kbps / 96 kbps / 128 kbps
Supported Protocol	IPv6 : TCP/IP, UDP/IP, HTTP, HTTPS, SSL/TLS, SMTP, DNS, NTP, SNMPv1/v2/v3, DHCPv6, RTP, MLD, ICMP, ARP, IEEE 802.1X, DiffServ, FTP, SFTP, MQTT, LLDP IPv4 : TCP/IP, UDP/IP, HTTP, HTTPS, SSL/TLS, RTSP, RTP, RTP/RTCP, SMTP, DHCP, DNS, DDNS, NTP, SNMPv1/v2/v3, UPnP, IGMP, ICMP, ARP, IEEE 802.1X, DiffServ, SRTP, FTP, SFTP, MQTT, LLDP
Max. concurrent access number	Up to 14 users (Depends on network conditions)
Secure	FIPS 140-2 level 3 (NXP® EdgeLock® SE050F), Device Certificate GlobalSign® pre-installed, HTTPS, User authentication, Digest authentication, Host authentication, IEEE802.1X, System log, Image transmission log, Brute-force protection, Alteration detection
SDXC/SDHC/SD Memory Card (Option)	H.265 / H.264 recording : Manual REC / Alarm REC (Pre/Post) / Schedule REC JPEG recording : Manual REC / Alarm REC (Pre/Post) Compatible SDXC/SDHC/SD card : 2 GB, 4 GB*, 8 GB*, 16 GB*, 32 GB*, 64 GB**, 128 GB**, 256 GB**, 512GB**model *SDHC card, ** SDXC card (except miniSD card and microSD card)

Mobile Terminal Compatibility	iPad / iPhone, Android™ terminals
ONVIF Profile	G / M / S / T
Alarm	
Alarm Source	3 terminals input, VMD, Command alarm
Alarm Actions	SDXC/SDHC/SD memory recording, E-mail notification, HTTP alarm notification, Indication on browser, TCP alarm notification output
Input/Output	
Monitor output (for adjustment)	VBS : 1.0 V [p-p] / 75 Ω, composite, ø3.5 mm mini jack An NTSC or PAL signal can be outputted from camera
Audio Input	[For microphone] ø3.5 mm stereo mini jack, Recommended applicable microphone : Plug-in power type (Sensitivity of microphone : -48 dB ±3 dB (0 dB=1 V / Pa,1 kHz)) Input impedance : Approx. 2 kΩ (unbalanced) Supply voltage : 2.5 V ±0.5 V [For line] Input level : Approx. -10 dBV
Audio Output	ø3.5 mm stereo mini jack (monaural output) Output impedance : Approx. 600 Ω (unbalanced) Output level : -20 dBV
External I/O Terminals	ALARM IN1 (Alarm input 1/ Black & white input/ Auto time adjustment input) (x1) ALARM IN2 (Alarm input 2/ ALARM OUT) (x1) ALARM IN3 (Alarm input 3/ AUX OUT) (x1)
General	
Safety	UL (UL62368-1), c-UL (CSA C22.2 No.62368-1), CE, IEC62368-1
EMC	FCC (Part15 ClassA), ICES003 ClassA, EN55032 ClassB, EN55035, ECE-R10, EN50498 compliant, EN50121
Power Source and Power Consumption	DC power supply : DC 12 V 1.1 A/Approx. 13.2 W PoE (IEEE802.3af compliant) Device : DC 48 V 270 mA/Approx. 12.95 W (Class 0 device)
Ambient Operating Temperature	IR LED : On -40 °C to +50 °C (-40 °F to 122 °F) Off -40 °C to +60 °C (-40 °F to 140 °F)
Ambient Operating Humidity	10 to 100 % (no condensation)
Anti-Condensation System	Rosahl element
Water and Dust Resistance	IP66 (IEC60529), Type 4X (UL50), NEMA 4X compliant
Shock Resistance	50J (IEC 60068-2-75 compliant), IK10 (IEC 62262)
Wind Resistance	Up to 40 m/s {approx. 89 mph}
Railway Application	EN50155-TX
Dimensions	When using the attachment plate only : ø154 mm × 60.3 mm (H) {ø6-1/16 inches × 2-3/8 inches (H)} Dome radius 35 mm {1-3/8 inches} When using the base bracket : ø164 mm × 96.3 mm (H) {ø6-15/32 inches × 3-25/32 inches (H)} Dome radius 35 mm {1-3/8 inches}
Mass (Approx.)	When using the attachment plate only : Approx. 880 g {1.94 lbs}, When using the base bracket : Approx. 1.3 kg {2.87 lbs}
Finish	Main body : Aluminum die cast, i-PRO white / Outer fixing screws : Stainless steel (Corrosion-resistant treatment) / Dome section : Polycarbonate resin, Clear

NOTES

Important

- Safety Precautions : Carefully read the Basic Information, Installation Guide and Operating Instructions before using this product.
- i-PRO Co., Ltd. cannot be held responsible for the performance of the network and/or other manufacturers' products used on the network.

- Masses and dimensions are approximate.
- Specifications are subject to change without notice.

Trademarks and registered trademarks

- iPad and iPhone are trademarks of Apple Inc., registered in the U.S. and other countries. - Android is a trademark of Google LLC.
- ONVIF is a trademark of ONVIF, Inc.
- All other trademarks identified herein are the property of their respective owners

©i-PRO Co., Ltd All rights reserved / March 2023

Bundled License

AI-VMD/AI People Counting with the 360-degree fisheye camera

AI Video Motion Detection

- AI differentiates between vehicles and people, detecting and sending warning notifications when an intruder enters a specified area.
- Intruder detection:** Issues an alarm when a moving object enters a specified area.
- Cross Line detection:** Issues an alarm when an object moving in the specified direction crosses a specified threshold.
- Loitering detection:** Issues an alarm when a moving object enters a specified area and stays there for a specified amount of time.

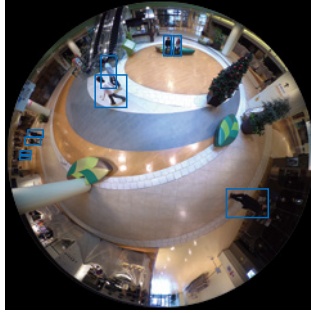

People Counting

- Cross Line Counting:** Counts the number of people moving in a specified direction and cross a specified threshold.
- Area Counting (Queue Management):** Counts the number of people in the set area.

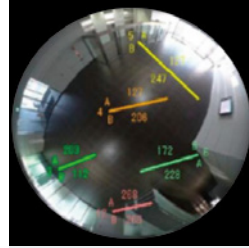

Cross Line Counting

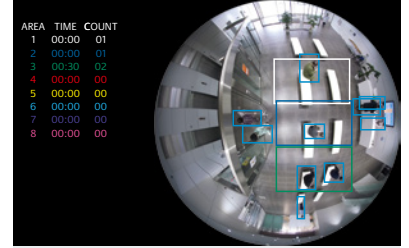

Area Counting

Heat map

- Heat mapping provides statistical information about traffic flow and keeps counts for people passing through and loitering in the area.

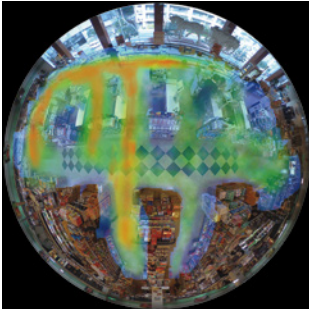

Passing



Loitering

Occupancy detection

- The network camera uses its AI engine to detect congestion, providing data that can be used to direct visitor traffic flow in advance or help staff work more efficiently.

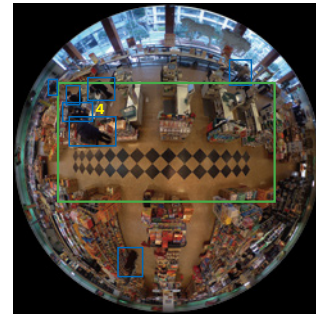

AI Privacy Guard for 360-degree fisheye

AI Privacy Guard

- AI can automatically mosaic faces and figures of people who are photographed to safeguard privacy and portrait rights.



Original image



Processed image

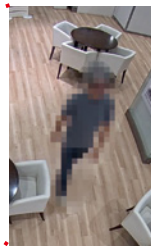

i-PRO Active Guard

- The i-PRO Active Guard stores the best images and metadata captured by i-PRO network cameras, then collates this data with the watch list registered in the client software and issues an alarm when a match is found. The server does not require expensive hardware because i-PRO network cameras handle the advanced processing. The server can even be installed on the same hardware as the VMS. The system comprises the i-PRO Active Guard, the AI application installed on i-PRO network cameras utilizing AI engines, and i-PRO Active Guard Plug-in software for the VMS client.

Example of basic system connection (without i-PRO Active Guard)

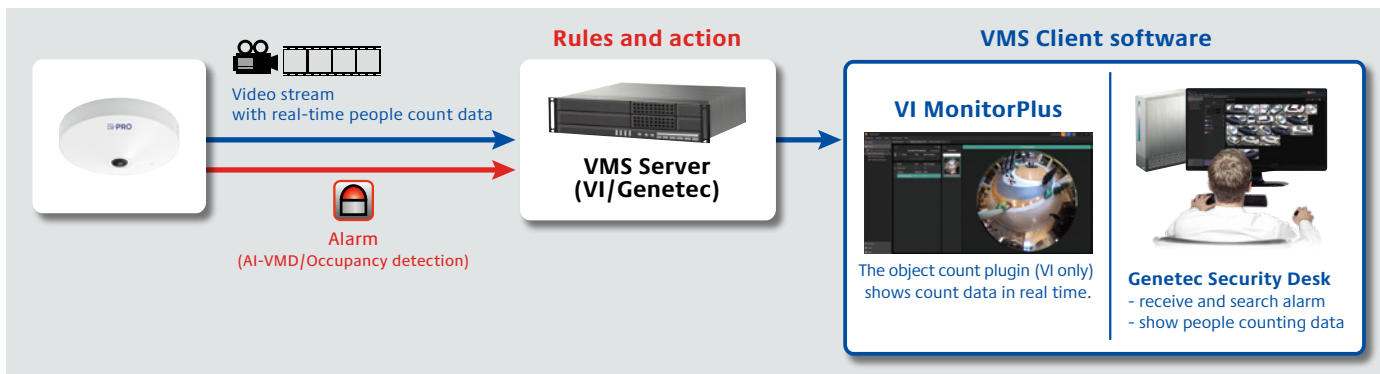

Example of basic system connection (with i-PRO Active Guard) for Video Insight/Genetec

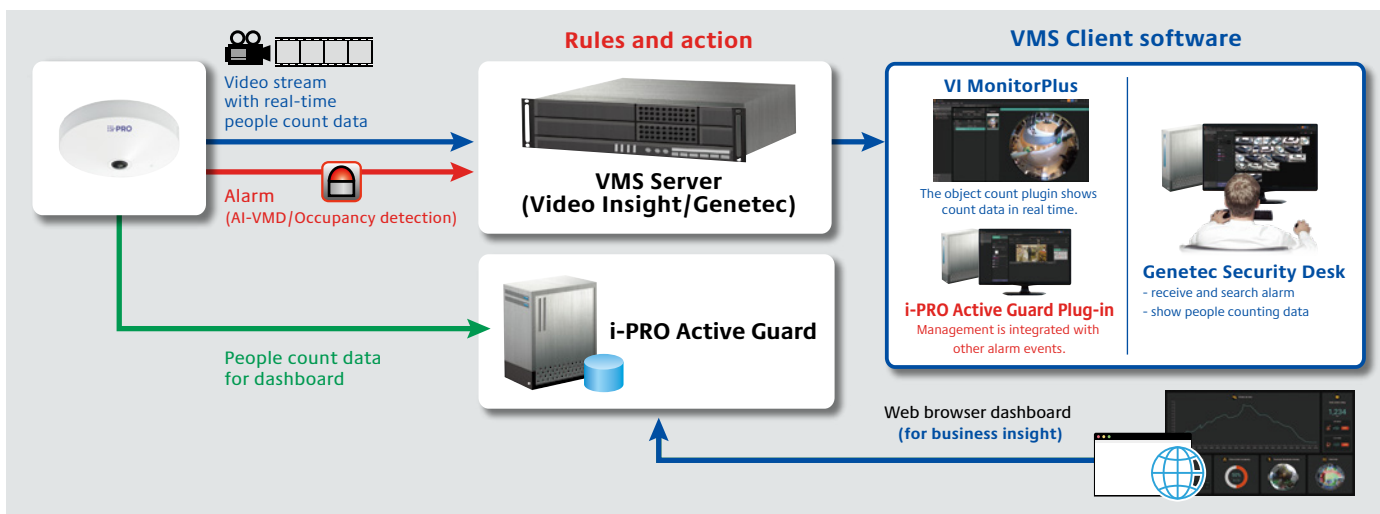

*VMS Server and i-PRO Active Guard can be installed on the same server.

Example of basic system connection for WV-ASM300W/Network disk recorder

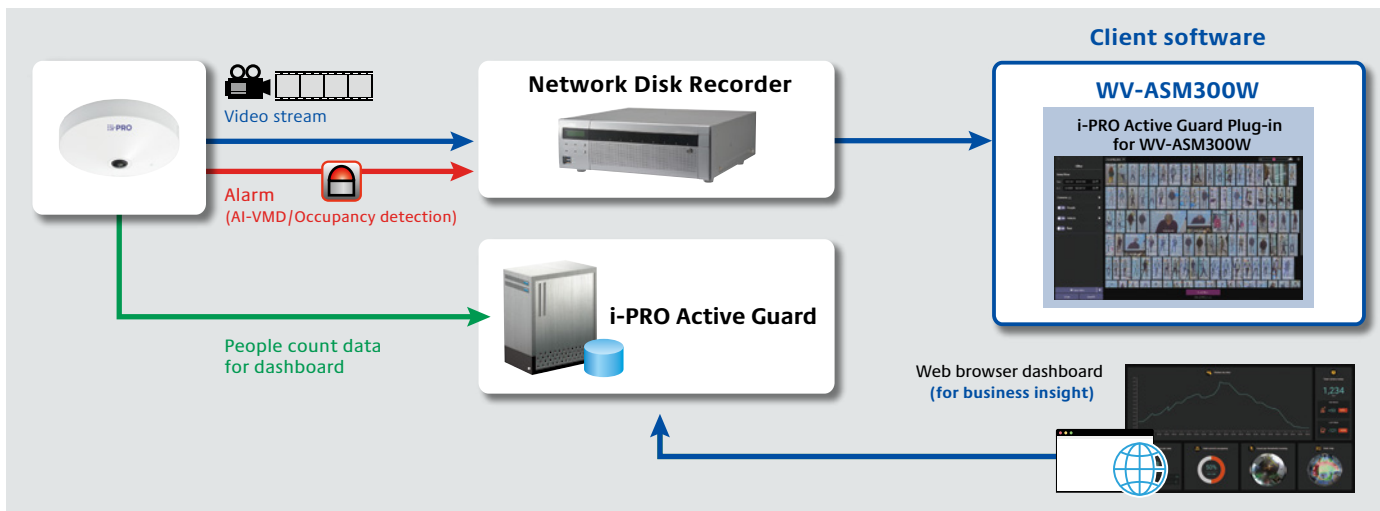

OPTIONAL ACCESSORIES

Select a compatible accessory

[Accessory Selector \(i-pro.com\)](http://i-pro.com).



WV-Q105A
Mount Bracket



WV-QCL100-W
Mount Bracket



WV-QCL101-W
Mount Bracket



WV-QCL102-W
Universal Camera
Mount Bracket



WV-QCL501-W
Mount Bracket



WV-QCN500-W
Mount Bracket



WV-QJB500-W
Mount Bracket



WV-QJB504-W
Base Bracket



WV-QLR100-W
Light Rail Mount
Bracket



WV-QPL500-W
Mount Bracket



WV-QSR501-W
Mount Bracket



WV-QWL500-W
Mount Bracket



WV-QWL501-W
Mount Bracket



WV-S25F1
Unit



WV-PM500
Compact microphone
unit for surveillance
cameras

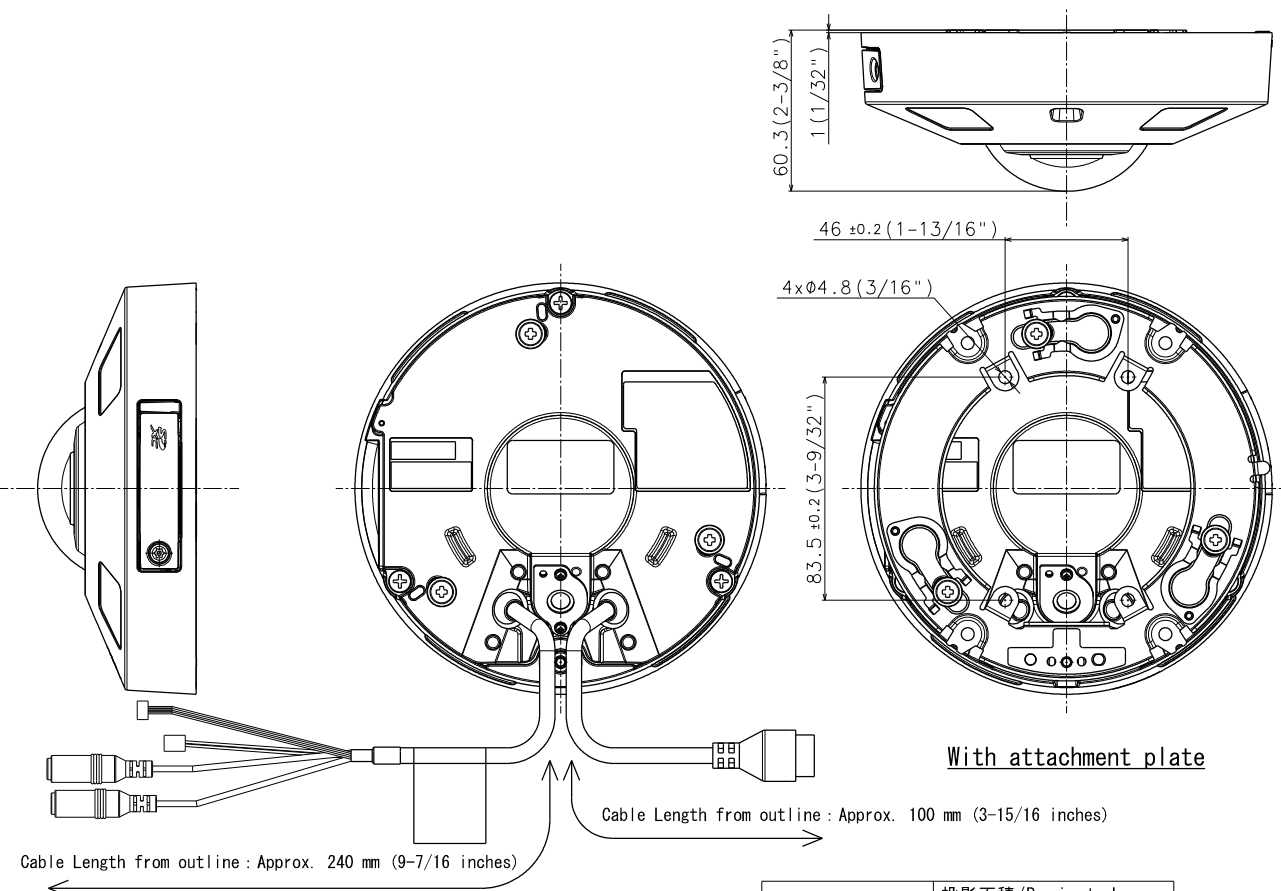
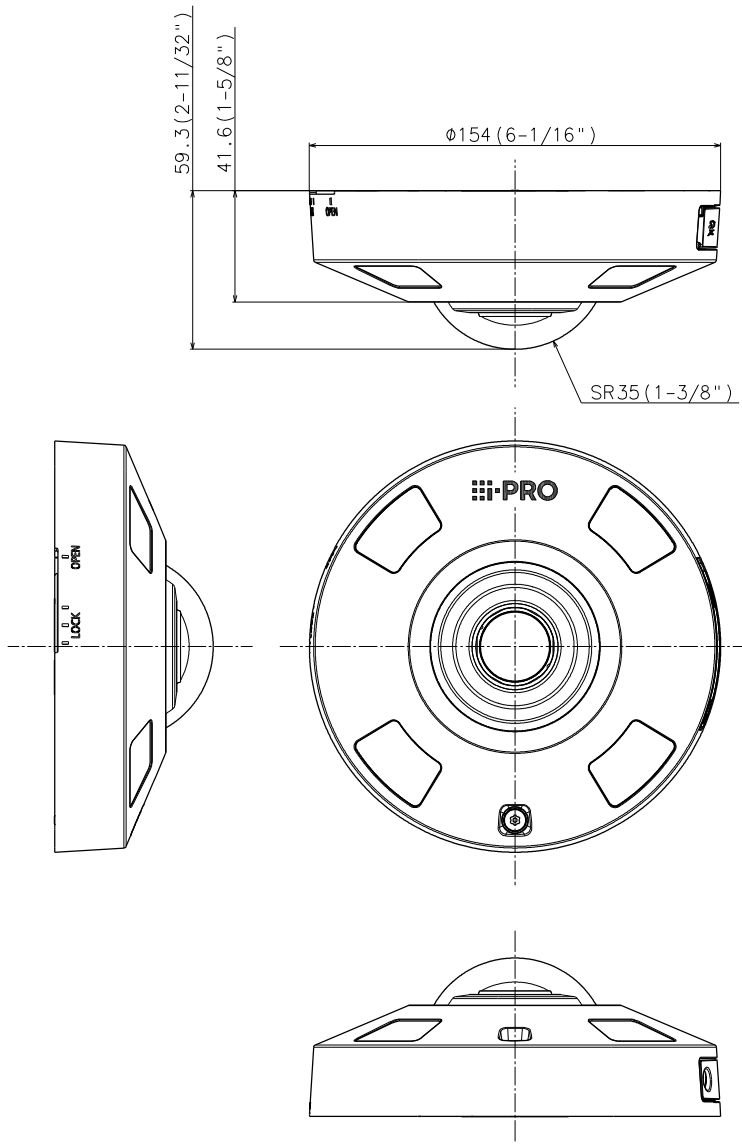

側面図/Side-view	投影面積/Projected area 0.007 (m ²)
---------------	--

Mass : Approx. 880 g {1.94 lbs} (When using the attachment plate)